

BI

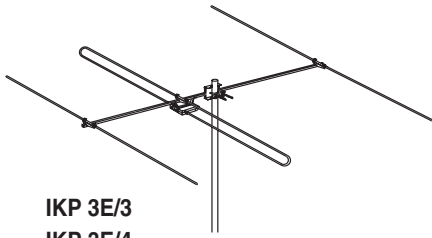

**IKP 3E/3
IKP 3E/4**

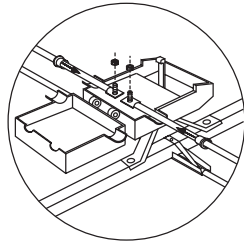
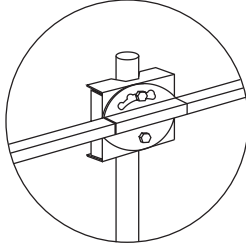
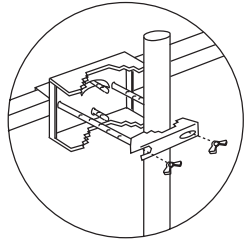
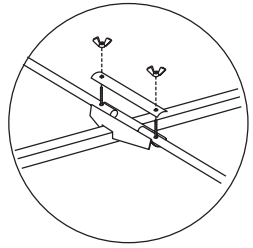
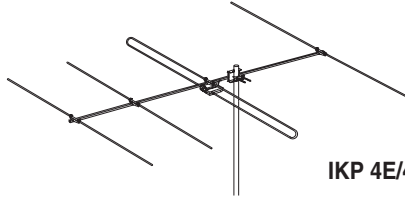

IKP 4E/4

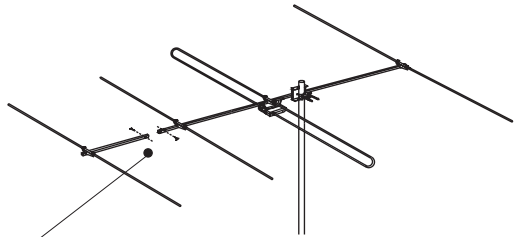

**IKP 4E/2
IKP 4E/3**

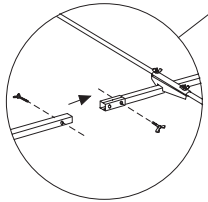

FM

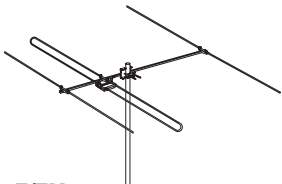

IKS 3E/FM

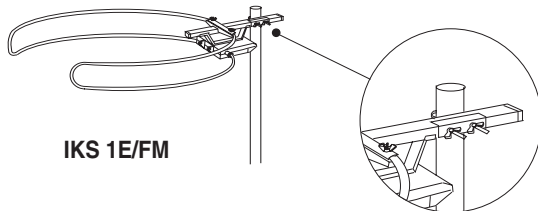

IKS 1E/FM

DAB

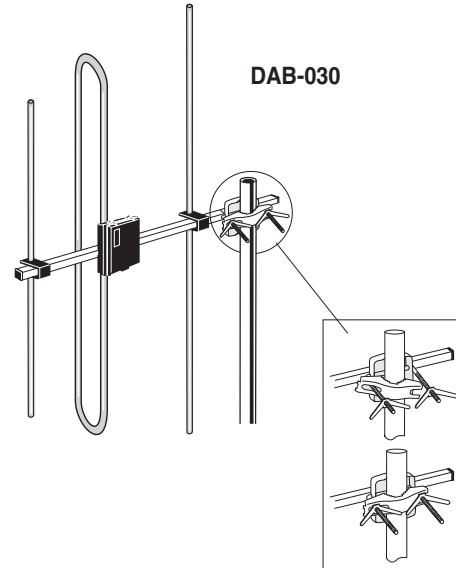
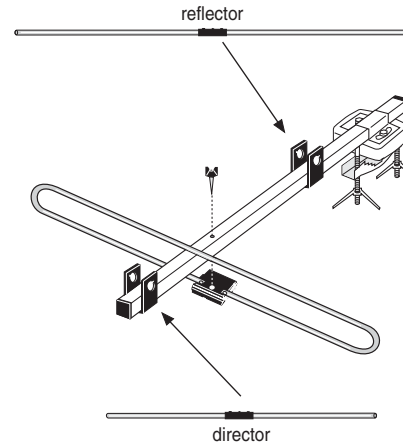

DAB-030

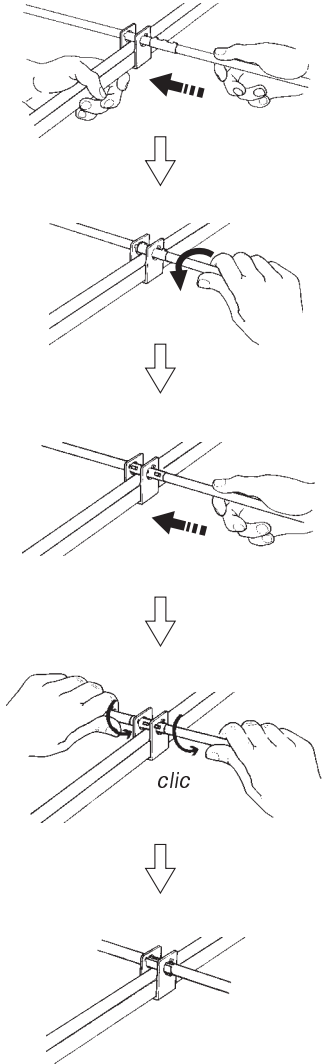

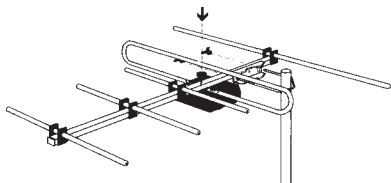

INT-050

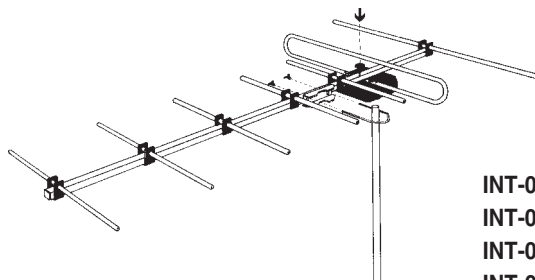

**INT-070
INT-071
INT-072
INT-073
INT-074**

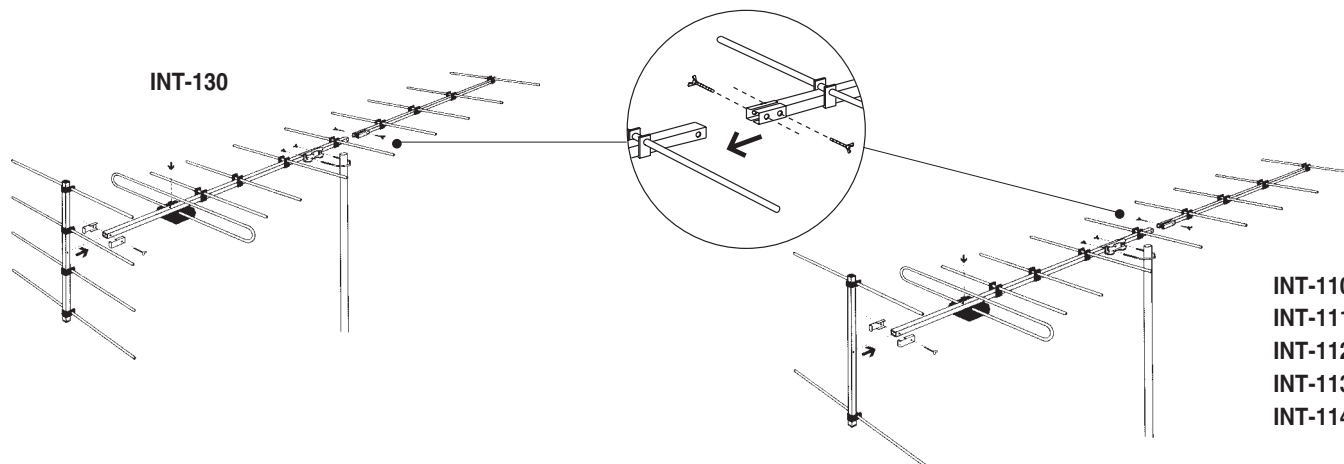
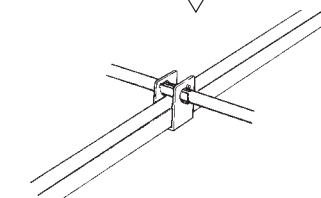
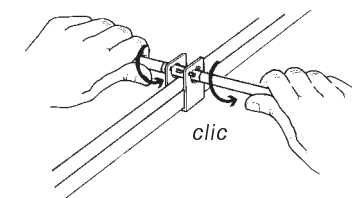
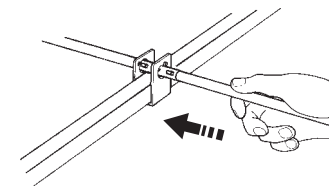
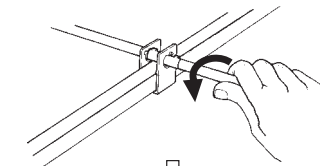
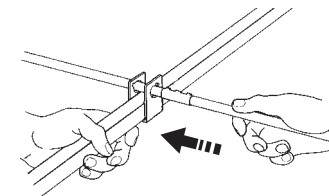

INT-130

**INT-110
INT-111
INT-112
INT-113
INT-114**